

TYPE #1

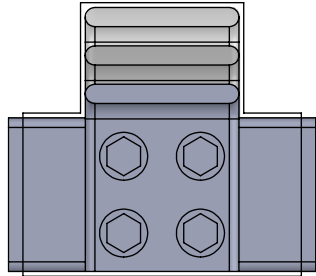

TYPE #2

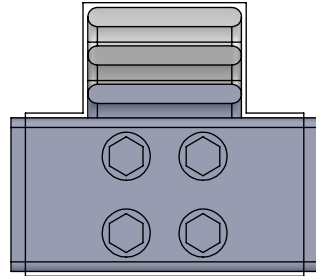

TYPE #1

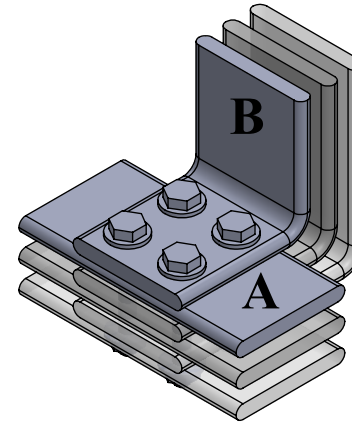

TYPE #2

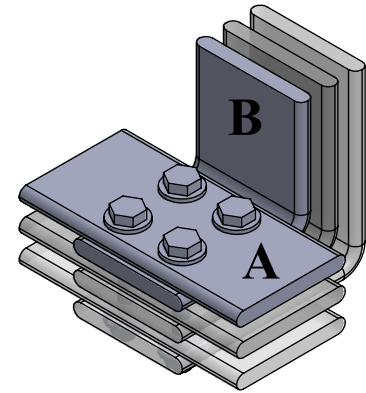

TYPE #1

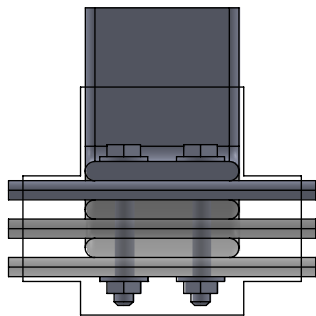

TYPE #2

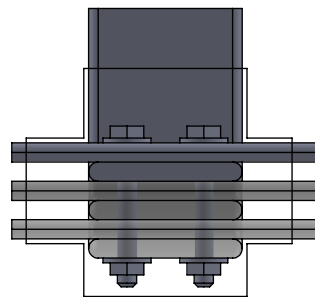

TYPE #1

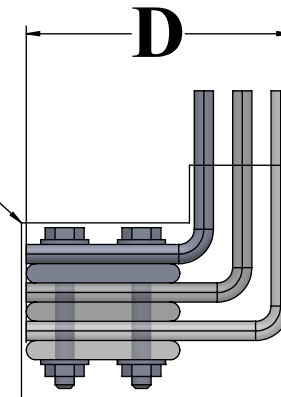

TYPE #2

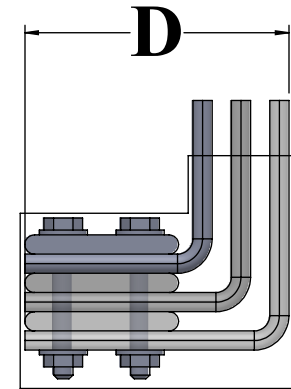

NOTE:

NOMINAL ½" ALLOWANCE FOR BOLT HEAD POCKET

NOMINAL 1" ALLOWANCE FOR NUT & THROUGH BOLT POCKET

NOMINAL 1" OUTLET LENGTH